

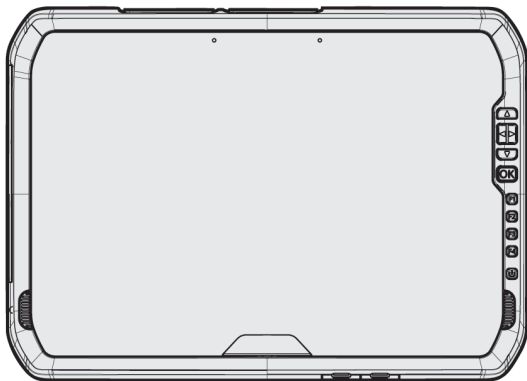

Trimble T100

TABLET



 **CAUTION** – Please read the full user guide including all safety warnings, before operating this product.



In the box

- ▶ Trimble T100 tablet with integrated batteries
- ▶ AC-DC USB-C power adapter
- ▶ USB-C to USB-A adapter
- ▶ Quick Start Guide
- ▶ EMR stylus with replacement tips and tether
- ▶ Screen protector

PARTS OF THE TRIMBLE T100 TABLET

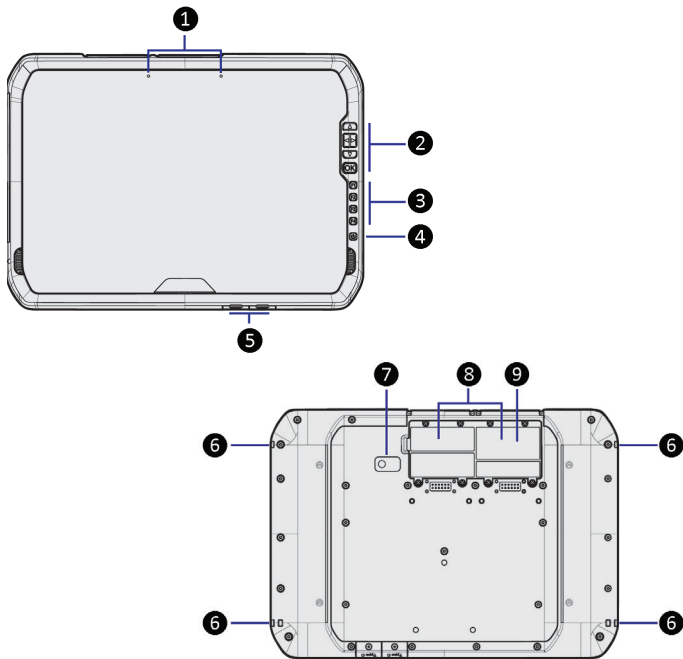

- | | |
|--------------------------------------|--|
| 1 Dual microphones | 6 Stylus tether loops (x4) |
| 2 Directional pad & OK button | 7 Camera and LED flash |
| 3 Function keys (x4) | 8 Trimble EMPOWER module bays (x2) |
| 4 Power button | 9 MicroSIM & MicroSD card slots
(Remove door to access card slots) |
| 5 USB C-Type ports (x2) | |

INSTALL MicroSIM CARD / MicroSD CARD (OPTIONAL)

Remove door to access
MicroSIM card and
MicroSD card slots.

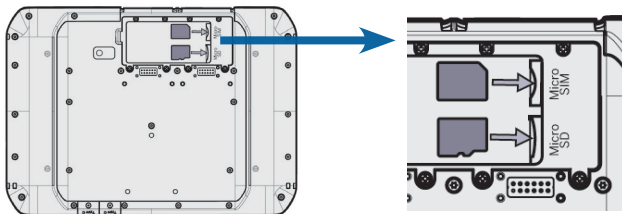

TETHER THE STYLUS. STORE IN THE STYLUS HOLDER

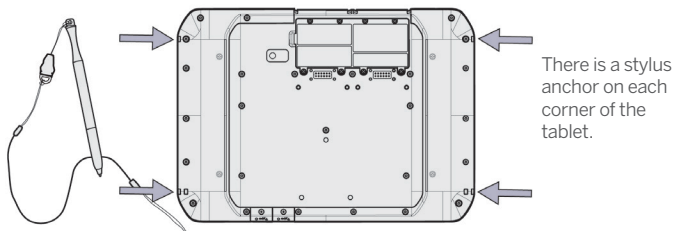

INSTALL THE SCREEN PROTECTOR

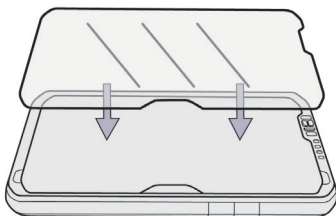

FULLY CHARGE THE BATTERY FOR 4 HOURS

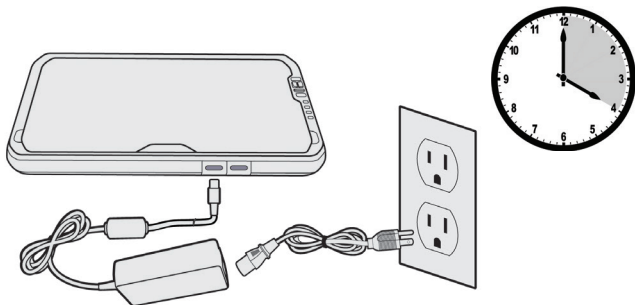

TURN ON AND SET UP THE T100 TABLET

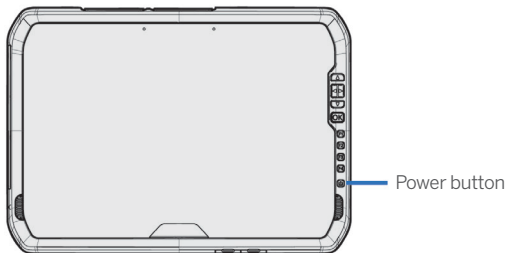

© 2020. Trimble Inc. All rights reserved. Trimble and the Globe & Triangle logo are trademarks of Trimble, registered in the United States and in other countries. All other trademarks are the property of their respective owners.
Revision A. P/N 120528-ENG (11/20)



www.trimble.com